



Light Up The Future

LED FLOODLIGHT ECO 100W

PRODUCT FEATRE

- THE STRUCTURE BE DESIGNED AND MADE OF DIE CASTING ALUMINUM FOR HIGHEST EFFECIENCY OF HEAT DISSIPATION
- THE FINISHED BLACK BODY POWDER PAINT SUITABLE FOR MANY AREA USAGE
- DELIVERS THE SYMMETRY LIGHT BEAM ANGLE OF 120 DEGREE WITH EASY ANGLE ADJUSTABLE BY SCREW LOCKING
- THE 4mm. TEMPERED GLASS COVER BE WITHSTAND THE IMPACT TEST OF LEVEL IK07
- BE ABLE TO USE BOTH OF INDOOR AND OUTDOOR APPLICATION WITH RATING OF IP 65
- THE SMD TECHNOLOGY FOR LED CHIPS GIVE MUCH EFFICIENCY
- LONG LASTING USAGE WITH COMPATIBLE PRICE

Specification

Model	LED Floodlight ECO 100W DL(IM)
WATTAGE (W)	100W
VOLTAGE (V)	AC220-240V 50/60Hz
POWER FACTOR	0.90
THDI(%)	<20%
COLOR TEMPERATURE (K)	6500K
BEAM ANGLE (°)	120°
LUMINOUS FLUX (LM)	9,000Lm
WORKING TEMPERATURE (°C)	-10 °C~45 °C
LIFE TIME (HRS)	40,000hrs
DEGREE OF PROTECTION	IP65
WEIGHT (KG)	1.83 Kg.

Brightness of light

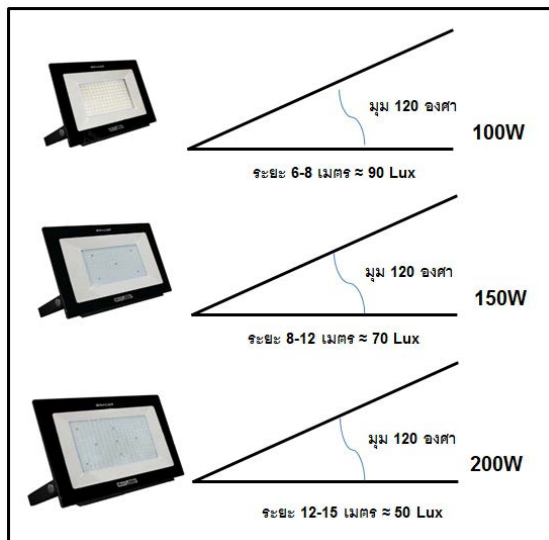

Product Dimension

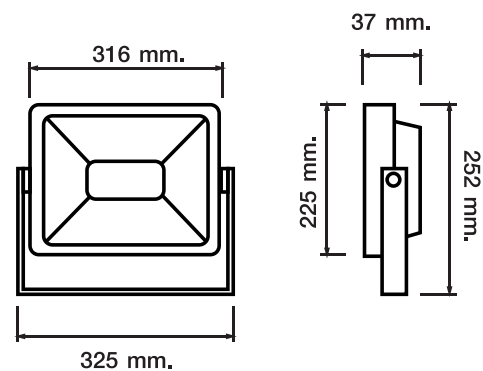

TIS 1955-2551